

MIDISPY TRIMLESS IN

DEEL
PARTIE
TEIL
PART
PARTE
PARTE **A**

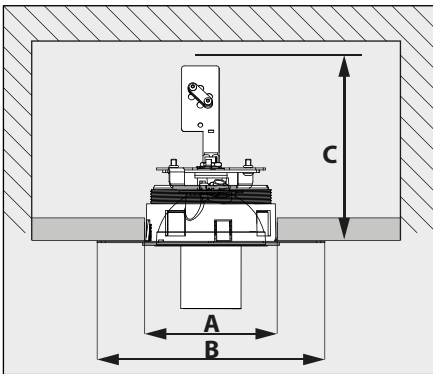
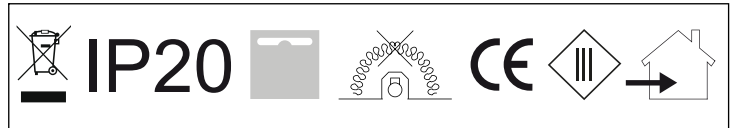
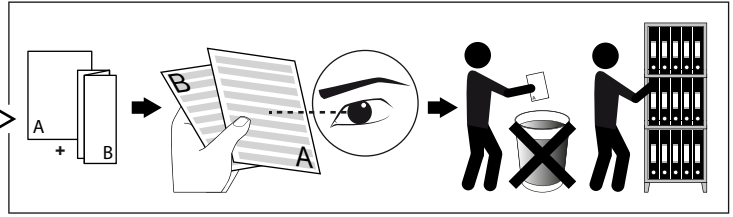
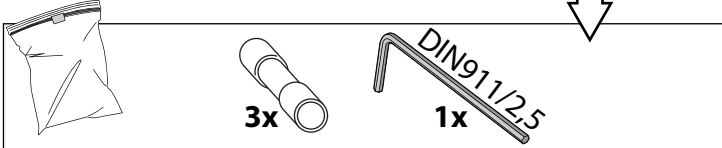

		mm
	A	KIT
	B	KIT
	C	80

REQUIREMENTS

MIDISPY TUBE	414 03 00
MOUNTING KIT MIDISPY	
TRIMLESS O.F.A.	414 21 00

li	350mA
P	6,4W
U _f	18,3V-DC

IP20

Beschermd tegen vaste voorwerpen die groter zijn dan 12 mm
 Protégé contre les objets solides de plus de 12 mm
 Geschützt gegen Festkörper größer als 12 mm
 Protected against solid objects greater than 12 mm
 Protegido contra objetos sólidos superiores a 12 mm
 Protetto contro oggetti solidi più grandi di 12 mm

Enkel geschikt voor toestellen op zeer lage spanning (minder dan 50 V-AC / 120 V-DC)
 Convient uniquement pour les produits à très basse tension (moins de 50 V-AC / 120 V-DC)
 Geeignet für Güter mit sehr niedriger Spannung (unter 50 V-AC / 120 V-DC)
 Only suited for goods at very low voltage (below 50 V-AC / 120 V-DC)
 Se recomienda únicamente para aquellos productos de tensión muy baja (menos de 50 V-AC / 120 V-DC)
 Vale unicamente per i prodotti a tensione molto bassa (inferiore a 50 V-AC / 120 V-DC)

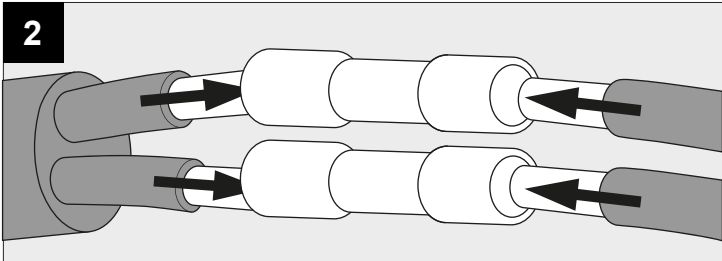
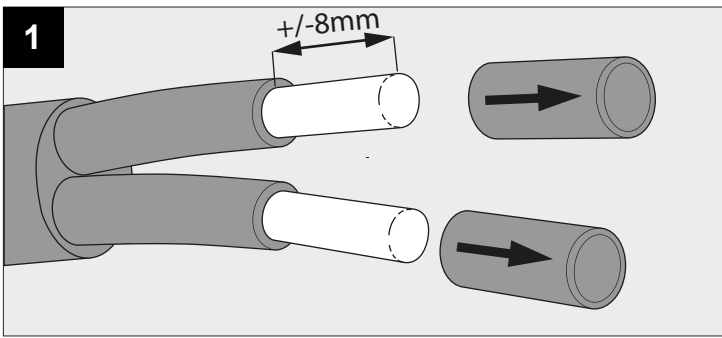

Toestel niet geschikt om te worden afgedekt met thermische isolatie.
 Luminaires non appropriées pour recouvrement d'un matériau isolant thermique.
 Das Gerät/Die Leuchte darf nicht abgedeckt werden mit thermischer Isolation.
 Luminaire not suitable for covering with insulating material.
 Luminaria no apta para cubrir con material aislante.
 Apparecchio non adatto per essere coperto da materiale isolante.

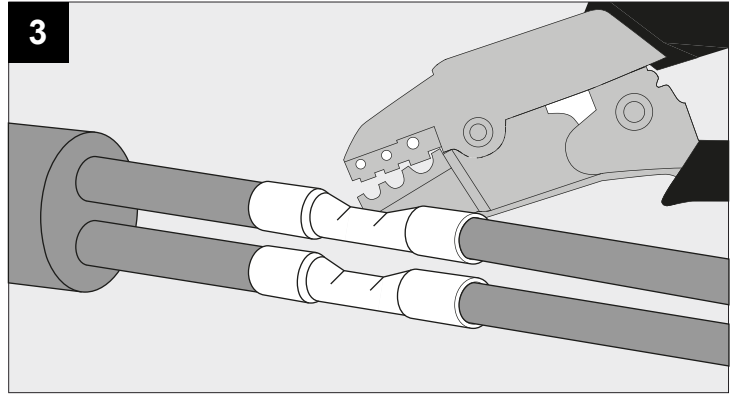

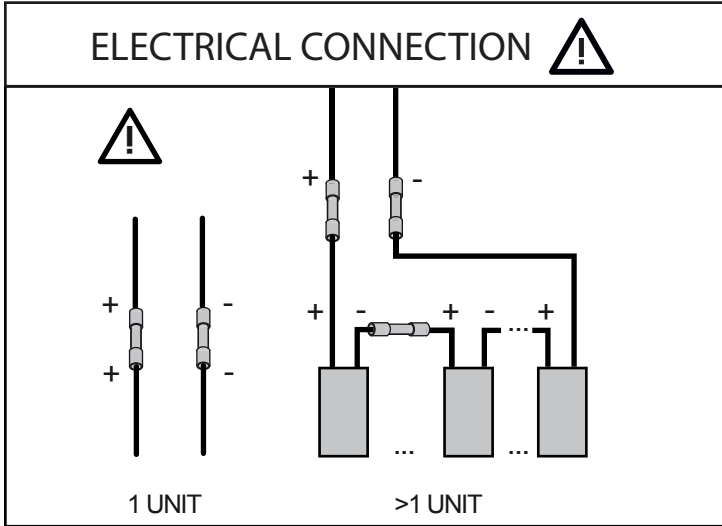

ATTENTION
OBSERVE PRECAUTIONS FOR
HANDLING ELECTROSTATIC
DISCHARGE SENSITIVE
DEVICES

NO SECONDARY SWITCHING

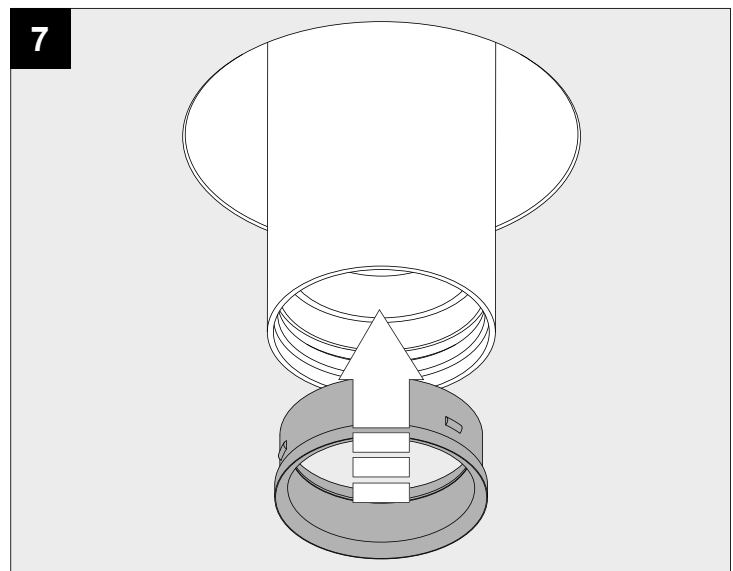
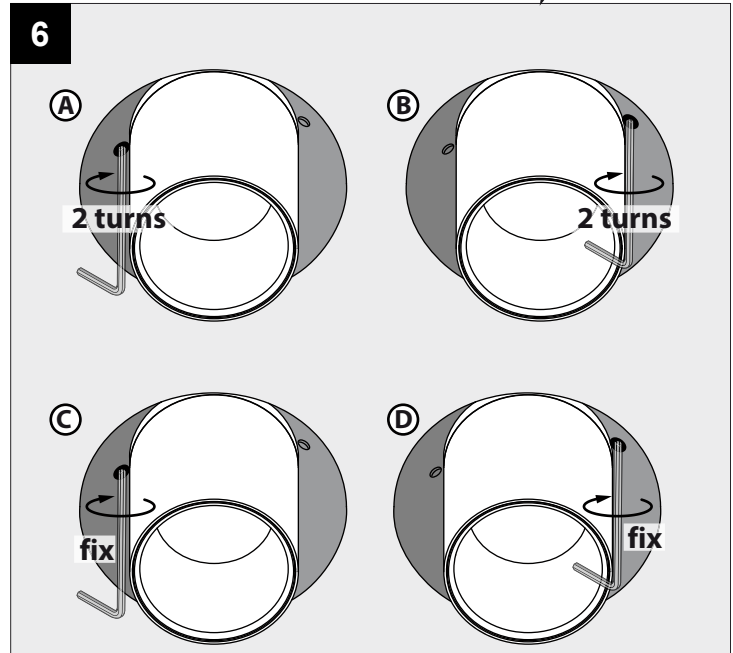
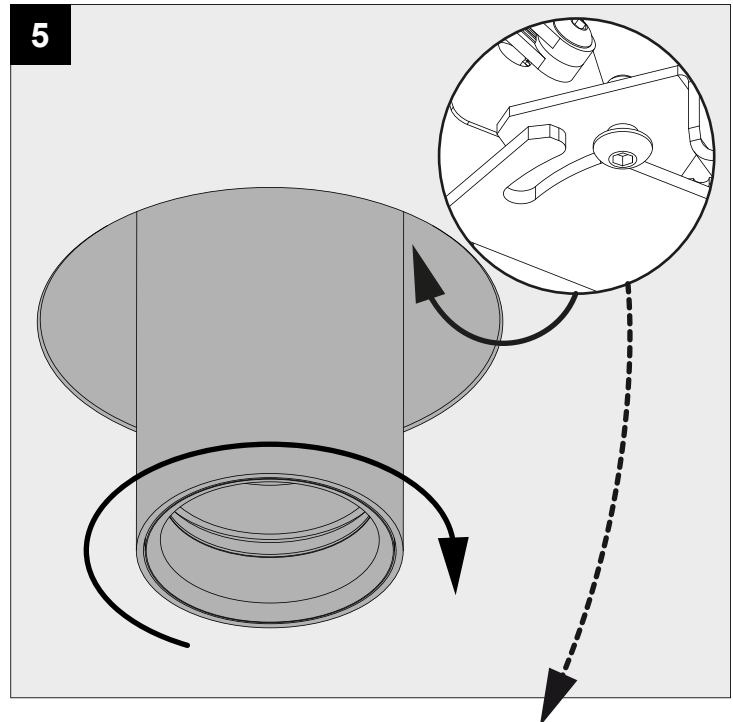
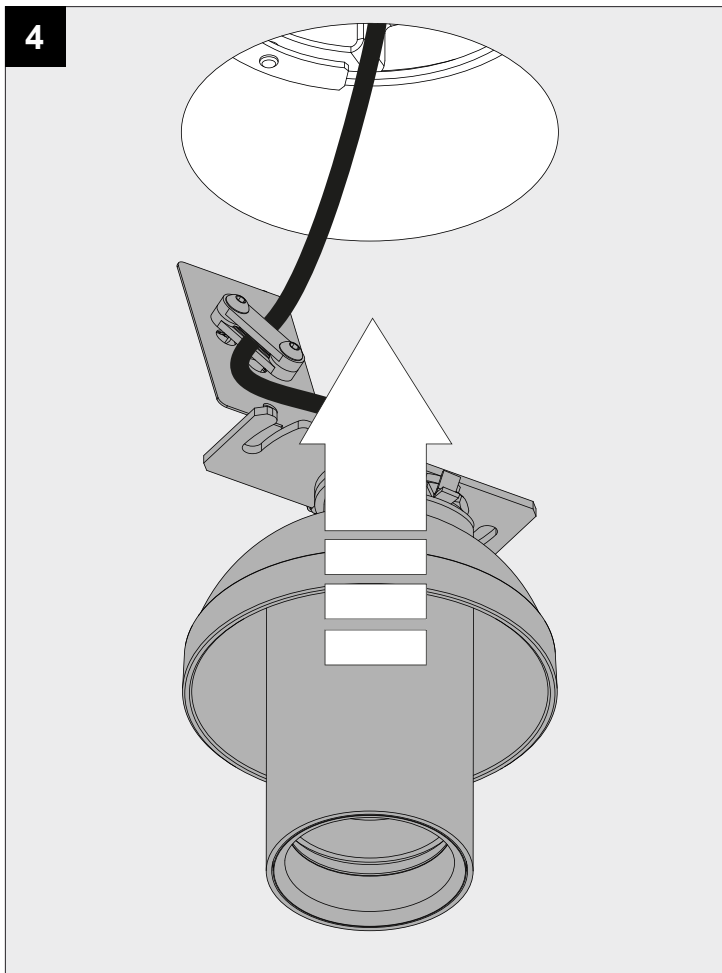

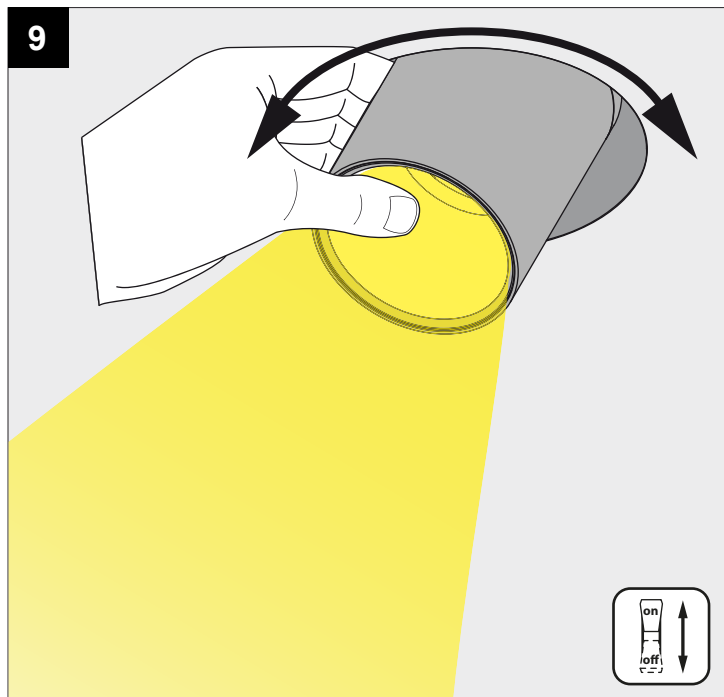
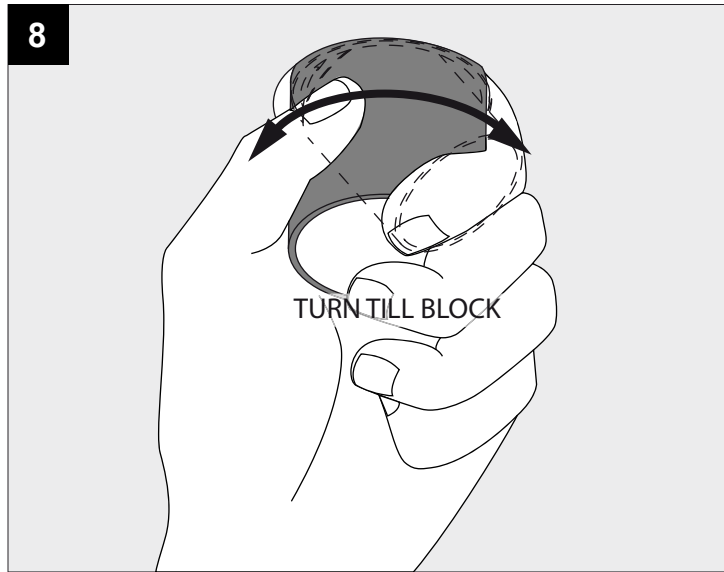

De verlichtingsbron van dit verlichtingstoestel zal enkel door de fabrikant of door de fabrikant aangestelde installateur vervangen worden.

La source lumière de cet appareil ne sera remplacée que par l'entreprise ou par un agent reconnu.

Das enthaltene Leuchtmittel sollte nur durch entsprechendes Fachpersonal ersetzt werden.

The light source contained in this luminaire shall only be replaced by the manufacturer or his service agent.

La fuente de iluminación que tiene esta luminaria sólo puede remplazarse por el fabricante o por un instalador autorizado.

La sorgente luminosa incorporata in questo apparecchio può essere sostituita solo dal produttore, da un suo centro assistenza oppure da una persona in possesso della necessaria abilitazione.